

DIGITAL REGULATION FOR TESLA MODULATOR POWER SUPPLIES

Niels Heidbrook, Hans-Jörg Eckoldt

Deutsches Elektronen Synchrotron DESY, Germany

Abstract

Modulators are used to supply pulsed power to the TESLA klystrons. Inside the modulator a capacitor bank stores energy to be released during the pulse. During the pulse the voltage droops for about 19 %. The capacitor is charged by a special power supply which suppresses the changes of power consumption from the mains. For these power supplies a regulation was developed. This regulation keeps the input power of the power supply constant. The accuracy of the initial klystron voltage from pulse to pulse is better than 0.5 %. A digital regulator based on a programmable ALTERA device including a RAM, a pre- filter, a linearisation and a self- learning algorithm was built. Via VME interface a communication with a control computer is possible. With an adequate pre- filter it is possible to regulate different kinds of power supplies which are used in modulators.

1. INTRODUCTION

To suppress the pulsed power consumption of klystron modulators from the mains two solutions have been developed at DESY.

1. A power supply with system specific constant power consumption. It is possible to use the power supply with a simple regulator including a pre- filter.
2. A digitally self learning regulator. With different pre- filters this regulator is able to work with many types of power supplies.

To take advantage of both solutions the special power supply and the digital regulator are combined in one modulator at DESY.

2. SERIES RESONANCE CONVERTER

The power supply shown in Figure 1 was developed at DESY.

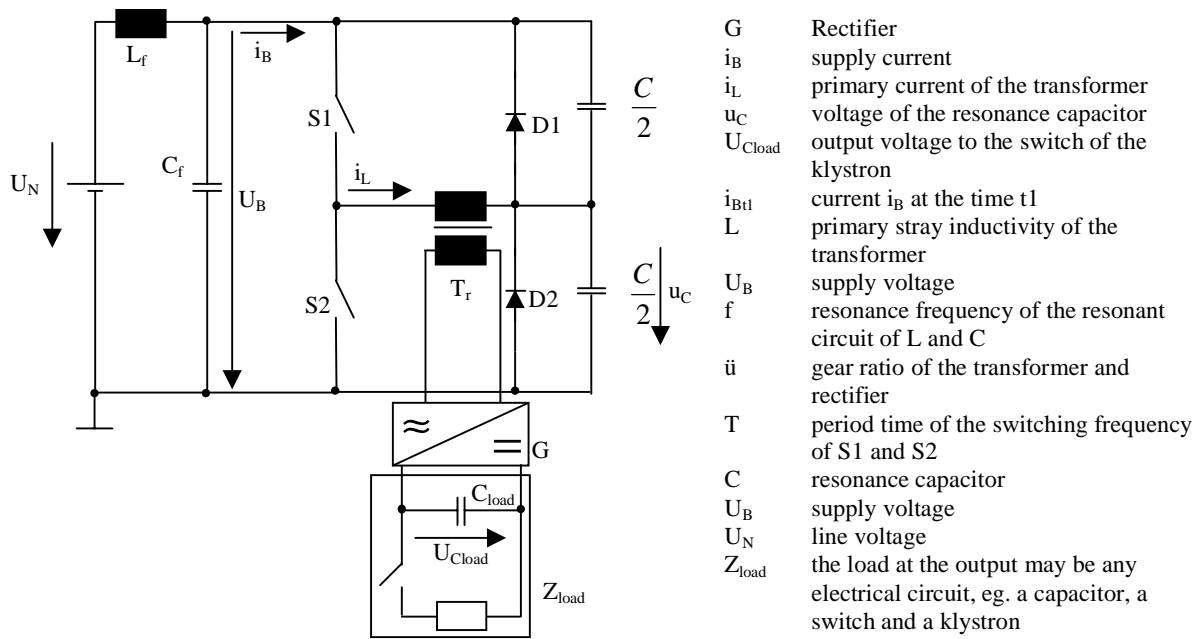

Figure 1: Series resonance converter

The capacitor C_{load} stores the energy for the klystron pulses. The zero current switching power supply supplies constant power to the load Z_{load} when the switching frequency f of S_1, S_2 is constant.

The equivalent circuit according to the arithmetic average of the supply current I_B :

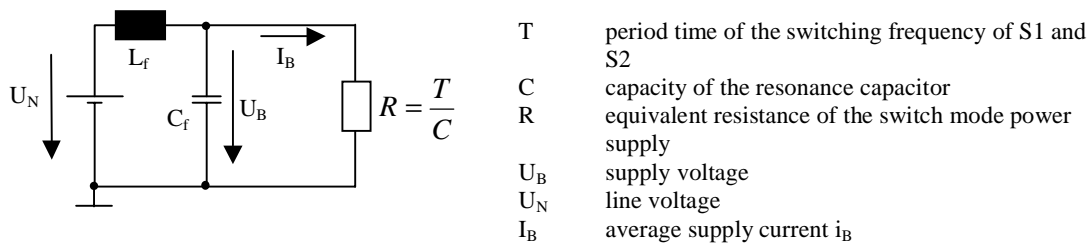

Figure 2: Equivalent circuit of the power supply

The equivalent circuit of the switch mode power supply is a resistor R which is constant when the period time T of the switching frequency f (10 kHz – 20 kHz) is constant. This resistance R is independent of the capacitor voltage U_{Cload} and the pulse repetition rate of the modulator. Therefore the input power is (in a wide range) independent from the voltage of the main capacitor bank of the modulator.

To describe the function of the power supply Figure 3 is used.

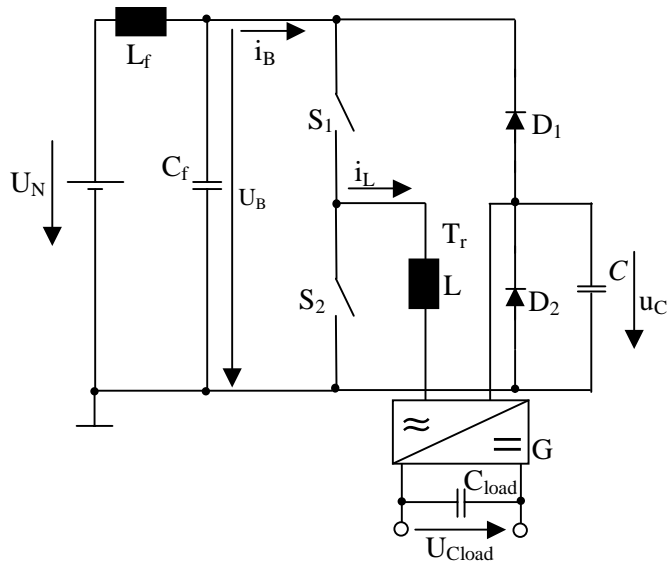

Figure 3: Series resonance converter with only one capacitor

The corresponding voltage and current waveforms of the following explanation may be seen in Figure 4.

Assumption: $u_c=0V$, $i_L=0A$ and S_1 turning on

Because of the stray inductance L of the transformer the current i_L keeps zero while turning S_1 on (zero current switching power supply). Then the current i_L raises and the resonance capacitor C is charged. While charging the resonance capacitor C the supply current i_B is equivalent to the resonance capacitor current i_L .

When the resonance capacitor voltage u_c reaches the supply voltage U_B diode D_1 will start to conduct. The current i_L continues flowing forced by the energy stored in the stray inductance L of the transformer. The energy stored in the stray inductance L of the transformer will slowly be passed to the load C_{load} and the current i_L decreases linearly to zero.

After that a new cycle can start by turning S_1 off and S_2 on. With each loading and unloading period the same amount of energy is transmitted from the primary side of the transformer to the main capacitor bank. This amount is the energy of the resonance capacitor loaded to the voltage U_B or unloaded to 0.

In Figure 1 the resonance capacitor C is divided into two capacitors $\frac{C}{2}$ having half the capacitance of

C . The same principle as for the half bridge with one resonance capacitor C is valid. The difference is that the frequency of the current i_B is doubled and the amplitude of i_B is divided by two. When one of the capacitors is loaded, the second capacitor is unloading and vice versa.

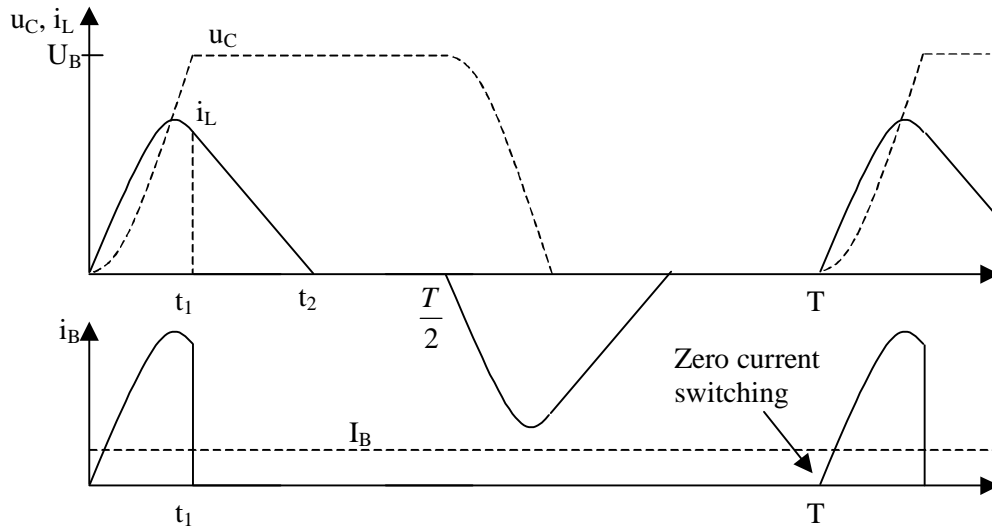

Figure 4: Voltage and current functions of the half-bridge

Please note that the current pulses are in the range of 20 kHz. They are filtered by the input filter and do not pass to the mains.

Derivation of the arithmetic average supply current I_B :

While charging the resonance capacitor C the supply current i_B is equivalent to the resonance capacitor current i_L . Therefore the charge Q taken from the power supply to the resonance capacitor C equals $Q = CU_B$.

The charge Q can be expressed as follows:

$$Q = \int_0^T i_B dt = CU_B$$

Multiplication of the integral with the term $\frac{T}{T}$ with T = period time of the switching time:

$$Q = T * \left[\frac{1}{T} \int_0^T i_B dt \right] = CU_B$$

The term in brackets is equivalent to the average supply current $I_B = \frac{1}{T} \int_0^T i_B dt$.

$$Q = T * I_B = CU_B$$

The resulting expression for the average supply current is:

$$I_B = \frac{CU_B}{T} = \frac{U_B}{R} \text{ with } R = \frac{T}{C}$$

The result of the derivation was shown in Figure 2. Without making any proximity the equivalent resistance R is independent of the output voltage U_{load} and therefore even from the load itself (including C_{load} and the rectifier G).

The input power P_R is only dependent on the intermediate voltage U_B . This dependency may be suppressed by a simple pre- filter which steers the switching frequency $f = \frac{1}{T}$.

$$P_R = \frac{U_B^2}{R} = \frac{CU_B^2}{T} \quad \text{with } R = \frac{T}{C}$$

$$T = \frac{CU_B^2}{P_R}$$

With a desired power consumption P_R , the capacitance of the resonance capacitor C and the measurement of the intermediate voltage U_B the pre- filter $T = \frac{CU_B^2}{P_R}$ will calculate the period time

T of the switching frequency of the Switches S_1, S_2 .

Without having a regulator the power consumption is independent of any kind of load and independent of the mains voltage U_N .

To test the half bridge circuit a 300 kW prototype consisting out of four 75kW power modules has been build at DESY. Single power modules have been tested successfully, but so far there was no 300kW test.

The dependence of the input power to the capacitor voltage is shown in Figure 5. The curve forms are measured values of a small power supply prototype.

2.1 Pictures of the modulator power supply

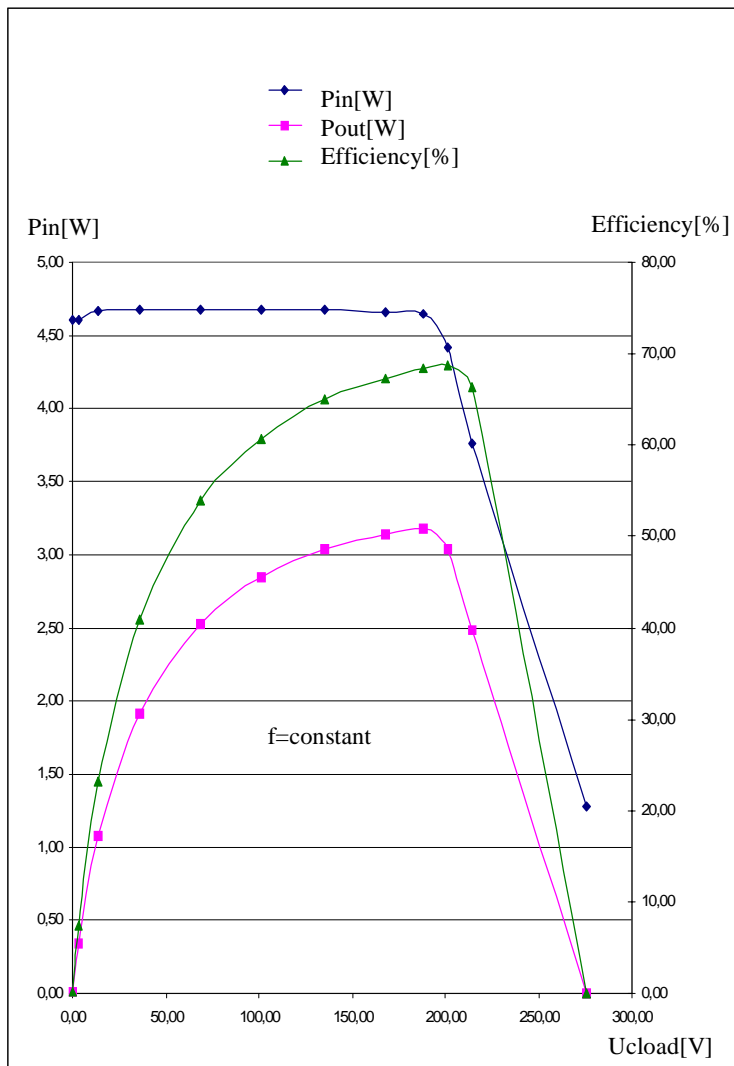

Figure 5: Power supply test circuit measurements

Conditions:

- 40W test power supply with system specific constant power consumption.
- Constant switching frequency f and varying output voltage U_{load} .
- No regulator or pre- filter is used.
- Because the small power prototype contains a 50Hz transformer instead of a 20kHz transformer the efficiency is 69% at maximum.

Without regulation or pre- filter the input power P_{in} is constant in a wide range of output voltages $U_{\text{load}} = 0\text{V}$ to $U_{\text{load}} = 200\text{V}$. It is not possible to pass energy to a short circuit output or open circuit output. Therefore the efficiency is zero at $U_{\text{load}} = 0\text{V}$ and $U_{\text{load}} = 275\text{V}$.

The test circuit proves the formula $P_{\text{in}} = \frac{CU_B^2}{T}$ of the derivation even with ‘worst case components’ like the 50Hz transformer.



Figure 6: 300kW switch mode power supply including four 75 kW modules



Figure 7: rear side of 300 kW switch mode power supply

3. REGULATION

The regulation is a major part of a constant power power supply. The voltage of the capacitor bank at the trigger time of the pulses has to have a pulse to pulse repetition accuracy of +/- 0.5%. This in combination with the demand of constant power requires a digital regulation. To be able to react on variations of the mains, temperature effects or non linear behavior of components the regulation is self learning. A simplified modulator circuit is shown in Figure 8.

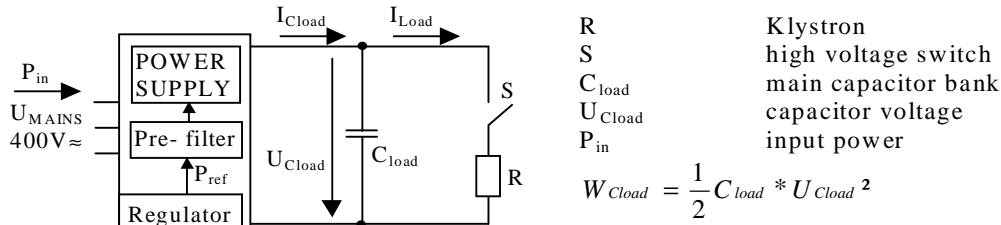

Figure 8: Simplified modulator circuit

3.1 Principle of regulation

The regulator contains a RAM wherein the charging curve of the capacitor voltage U_{Cload} is stored. The capacitor voltage U_{Cload} is driven according to the RAM curve. A fast regulator ensures that the RAM curve and the capacitor voltage U_{Cload} are equal despite of even fast voltage variations of the mains voltage U_{MAINS} . For this reason it is obvious that the final voltage $U_e = U_{Cload}$ at time t_e remains the same at each charging cycle because it equals the well known RAM curve. Figure 9 shows the voltage curve of the main capacitor bank.

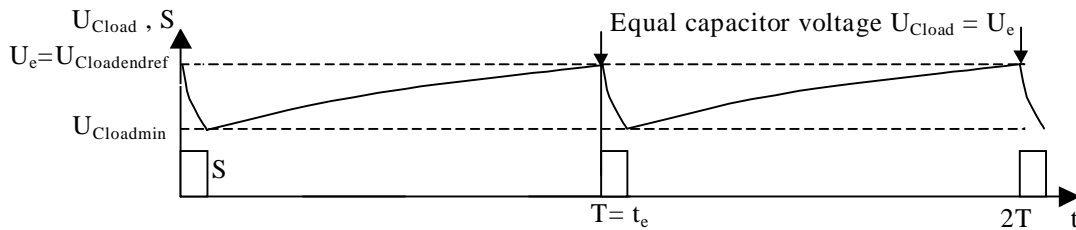

Figure 9: Voltage curve of the main capacitor

To achieve constant input power a learning process is introduced. A voltage charging curve for C_{load} is determined. With this curve the final charging voltage equals the nominal voltage ($V_{capend} = V_{capendref}$). This charging curve is stored in the memory. The possible starting curve is shown in Figure 10.

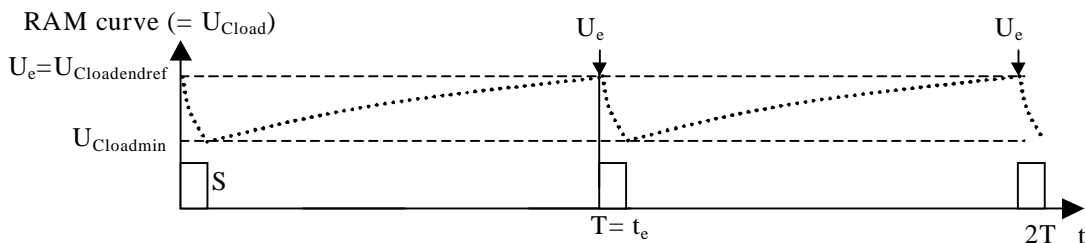

Figure 10: Stored reference charging curve of the capacitor

With this reference charging curve the input power is not yet constant but looks e.g. like the curve shown in Figure 11. The aim is to have constant power. With the self learning algorithm the stored

reference curve is modified in such a way that the reference values are increased or decreased until the input power is constant.

The result of the learning process is equal output voltage $U_{\text{Cload}} = U_e = \text{constant}$ after each charging cycle T and constant input power consumption $P_{\text{in}} = P_{\text{average}} = \text{constant}$.

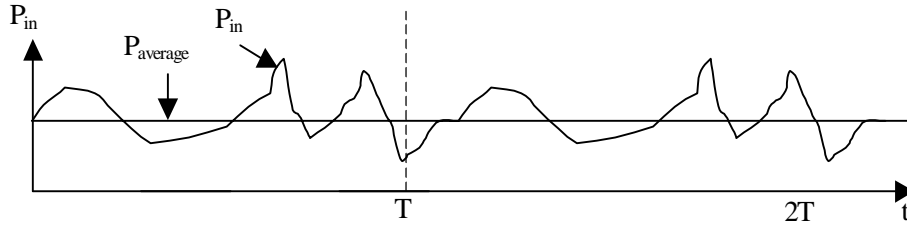

Figure 11: Input power of the modulator

3.2 Regulation with unit RAM curve

To be independent from changes in the charging time T (changes in repetition rate) or the output voltage U_e a unit curve is stored in the RAM. By this it is not necessary to relearn this curve in case of change. The unit charging curve is simply scaled to the real time and voltage axis.

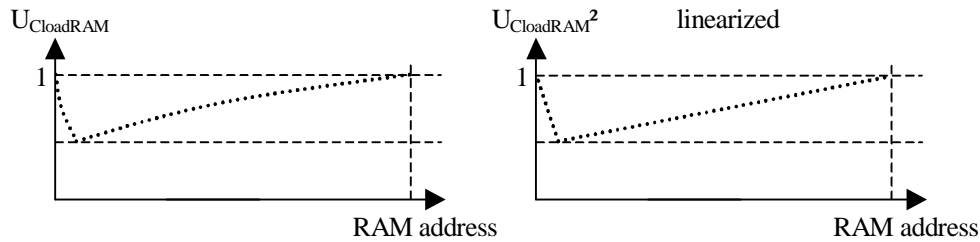

Figure 12: RAM curves of the capacitor reference curves

To linearize the regulation the capacitor voltages are used as squared values. This is because the energy stored in the capacitor C_{Load} is proportional to the squared capacitor voltage U_{Cload}^2 . The linearized curve is stored as RAM curve.

$$W_{\text{Cload}} = \frac{1}{2} C_{\text{load}} * U_{\text{Cload}}^2$$

$U_{\text{Cloadref}}^2(t)$ (reference curve) is the linearized reference value of the squared capacitor voltage $U_{\text{Cload}}^2(t)$ (actual curve) .

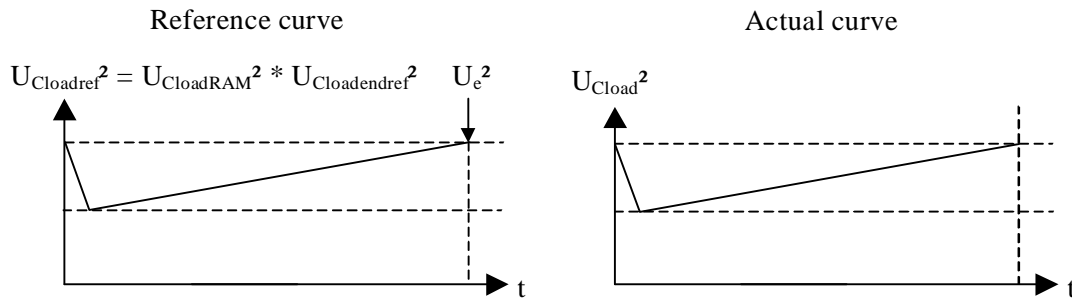

Figure 13: Linearized and scaled reference curve and monitored curve

The reference value $U_{Cloadref}^2$ and the linearized squared capacitor voltage U_{Cload}^2 are passed to a P-regulator.

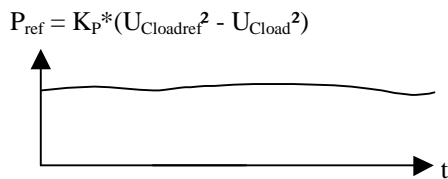

Figure 14: Output signal of the regulation

The signal P_{ref} is the signal steering the power consumption of the power supply (Figure 14). It is necessary that the actual input power P_{in} is proportional to the steering signal P_{ref} ($P_{in} \sim P_{ref}$). In some power supplies a pre-filter has to be used to ensure that $P_{in} \sim P_{ref}$. Droops of the mains voltage U_{MAINS} are the most disturbing error signals for the P(I) regulator. The pre-filter in the proposed power supply for TESLA guarantees the independence of the input power P_{in} from the mains voltage U_{MAINS} ($P_{ref} \sim P_{in} \neq f(U_{MAINS})$).

The hardware of the regulation is based on a programmable ALTERA device. The device contains the complete regulation software, the pulse firing generation of the switched mode power supply and the interlocks for the power supply. The designed board is able to work in local mode. A VME interface allows to communicate with a control computer to feed in pre-calculated curve forms for the modulator. By this the learning time is decreased.

The regulation scheme is shown in Figure 15.

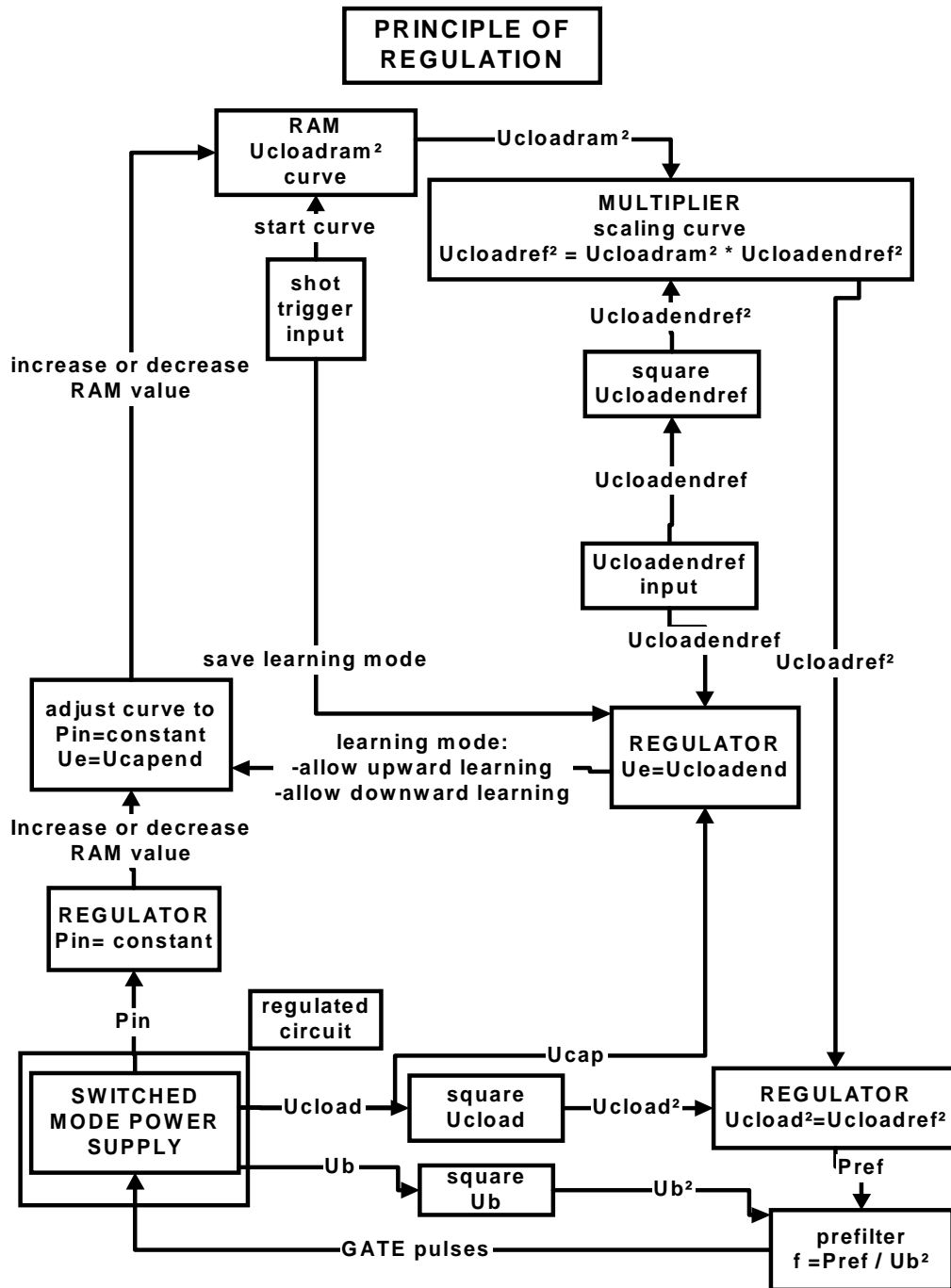

Figure 15: Block diagram of the self-learning regulation

The software modules shown in Figure 16 are implemented in the Altera FPGA device.

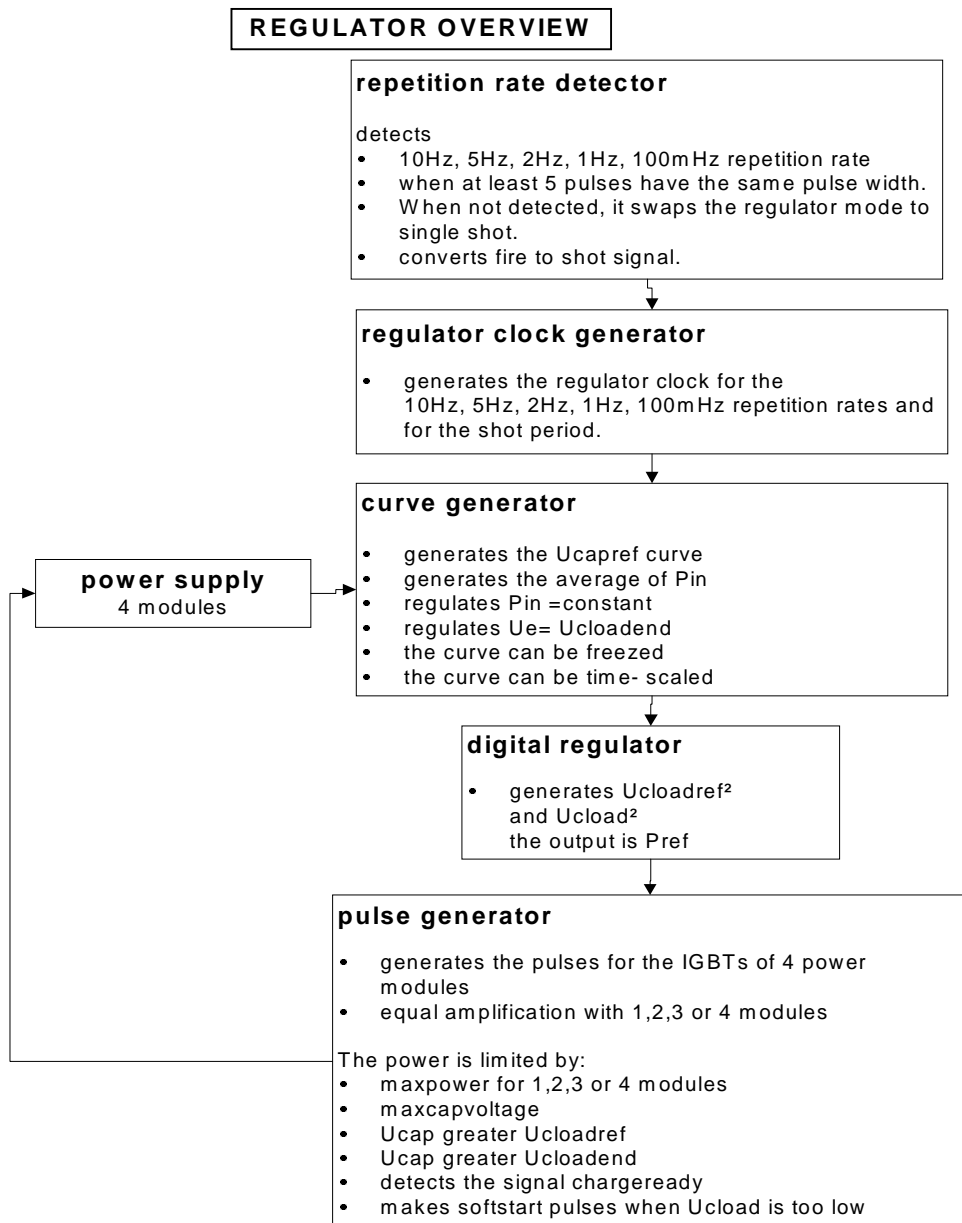

Figure 16: functional blocks in the Altera FPGA

The circuit board of the digital regulation is shown in Figure 17.

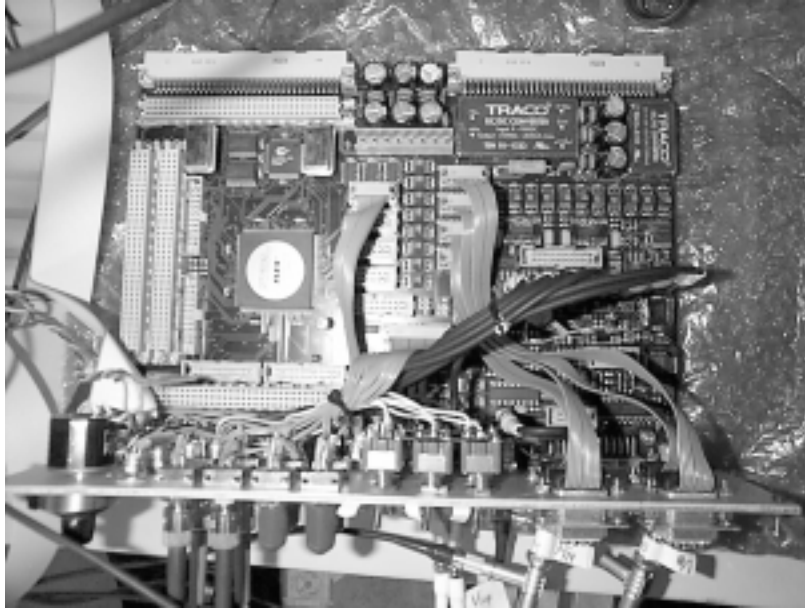

Figure 17: Top view of the digital regulator

Summary

The two different methods of power supplies have been developed and tested at DESY. The switch mode power supply already works with the desired precision using an analog regulator.

The digital regulator improves the rejection of fast disturbances such as fast droops of the mains voltage. The learning algorithm fits the charging curve to every working condition. The VME interface gives the option of downloading adjusted charging curves that are eliminating the voltage droop in the klystron voltage pulse.

Tests with other types of power supplies will follow in the future. The new self learning digital regulation will be a main part in other circuits because other power supplies may need complex pre-filters and might not be linear.

REFERENCES

- [1] DESY: Patent 'Elektrische Schaltung zur Reduzierung von Rückwirkungen auf eine Spannungsquelle', number 199 07 484.4 , 11.02.1999 Deutsches Patentamt München, Germany
- [2] Diplomarbeit: 'Entwurf und Simulation eines Umrichters mit schaltungsbedingt konstanter Leistungsaufnahme verifiziert durch Messungen', 28.02.1999 Niels Heidbrook @ TU Harburg, Germany
- [3] H.-J. Eckoldt, N. Heidbrook, Power Supplies for Modulators, DESY print. TESLA 2000-36
- [4] Hans-Jörg Eckoldt, Frederic Faubladiet, Niels Heidbrook, Constant power power supply for TESLA Modulator, EPAC 2000, Vienna